

- Nutzbare Fläche Nutentisch 1120mm x 1193mm
- 30er Nutgeometrie
- Nutabstand 40mm
- Max. Belastung Nutentisch: **720 kg**

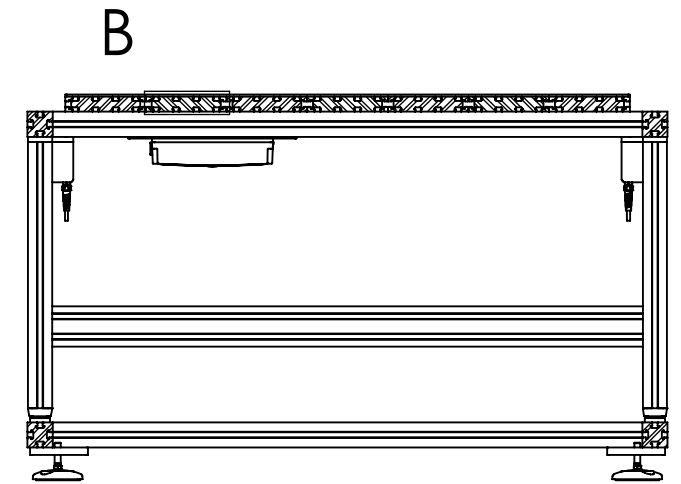

A-A

(30er Nutgeometrie)

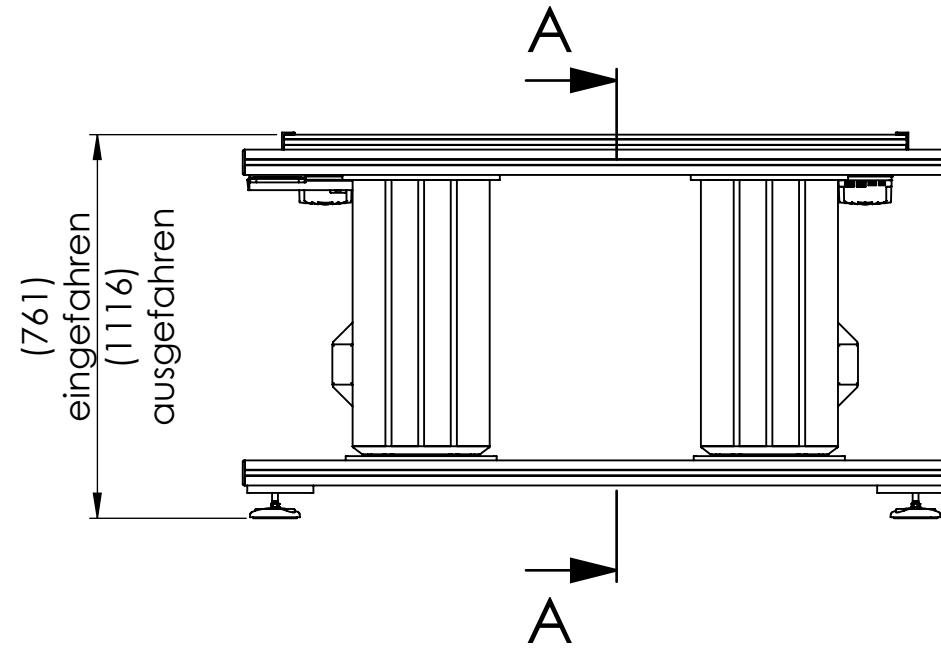