

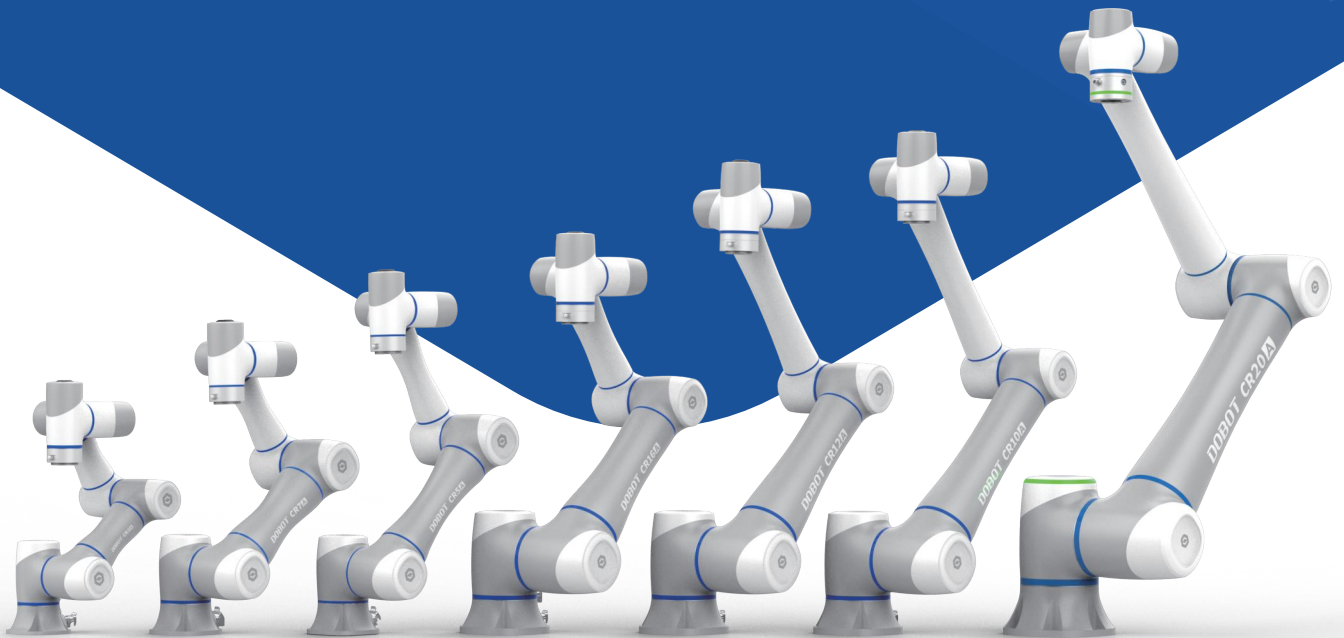

CRA  
SERIES



# CRA Series Collaborative Robot

New Benchmark for Collaboration

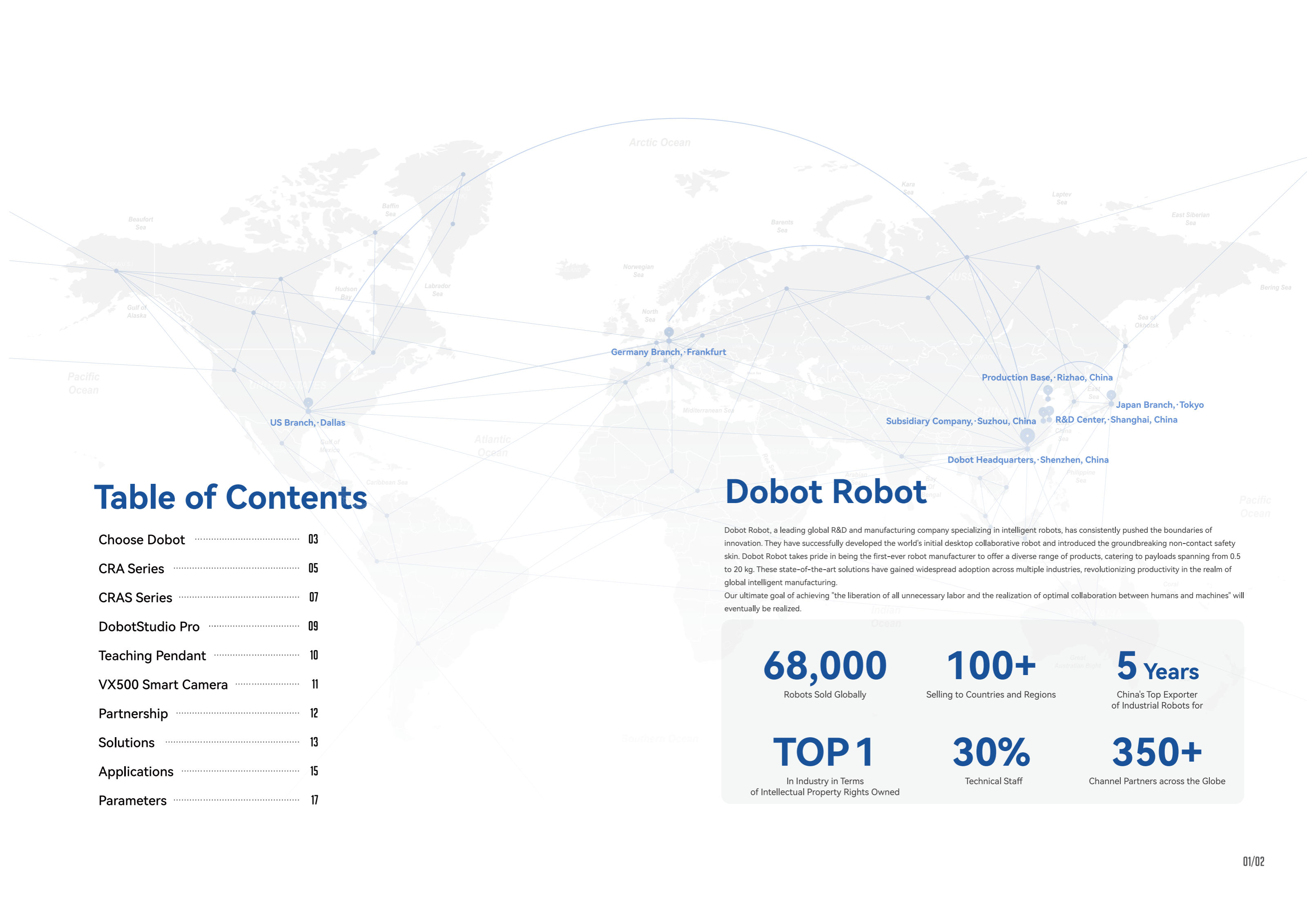

# Table of Contents

- Choose Dobot ..... 03
- CRA Series ..... 05
- CRAS Series ..... 07
- DobotStudio Pro ..... 09
- Teaching Pendant ..... 10
- VX500 Smart Camera ..... 11
- Partnership ..... 12
- Solutions ..... 13
- Applications ..... 15
- Parameters ..... 17

# Dobot Robot

Dobot Robot, a leading global R&D and manufacturing company specializing in intelligent robots, has consistently pushed the boundaries of innovation. They have successfully developed the world's initial desktop collaborative robot and introduced the groundbreaking non-contact safety skin. Dobot Robot takes pride in being the first-ever robot manufacturer to offer a diverse range of products, catering to payloads spanning from 0.5 to 20 kg. These state-of-the-art solutions have gained widespread adoption across multiple industries, revolutionizing productivity in the realm of global intelligent manufacturing. Our ultimate goal of achieving "the liberation of all unnecessary labor and the realization of optimal collaboration between humans and machines" will eventually be realized.

<h2 style="margin: 0;">68,000</h2> <p style="margin: 0;">Robots Sold Globally</p>	<h2 style="margin: 0;">100+</h2> <p style="margin: 0;">Selling to Countries and Regions</p>	<h2 style="margin: 0;">5 Years</h2> <p style="margin: 0;">China's Top Exporter of Industrial Robots for</p>
<h2 style="margin: 0;">TOP 1</h2> <p style="margin: 0;">In Industry in Terms of Intellectual Property Rights Owned</p>	<h2 style="margin: 0;">30%</h2> <p style="margin: 0;">Technical Staff</p>	<h2 style="margin: 0;">350+</h2> <p style="margin: 0;">Channel Partners across the Globe</p>

# Why Choose Dobot Collaborative Robots?



## Easy Deployment

Dobot's collaborative robots, being lightweight and compact, can be deployed with ease, eliminating the need for modifications to the existing production line or the installation of guardrails. By sharing the workspace with workers, they enhance the utilization of space on the production line effectively. Owing to their simple and user-friendly programming method, Dobot's collaborative robots reduce debugging time, enabling swift adaptation to diverse, small-batch production. They can also function as workstations, seamlessly transitioning between different stations to accommodate the need for flexible production.

Dobot offers a plethora of interfaces that facilitate the plug-and-play of mainstream peripherals, including grippers, vision, and extension axes. This results in expedited deployment and enhanced production efficiency.



## Straightforward operation

Dobot is an industry pioneer in implementing Blockly programming for collaborative robots. The functions of the robot are represented as blocks, offering a more intuitive and comprehensible approach. Users are not required to learn complex programming syntax. Instead, they can assemble the necessary blocks to create a program, providing flexibility and ease of use. With no prior experience, mastering Blockly programming takes just 45 minutes. Dobot has also developed specialized process packages for specific applications such as welding and palletizing. After simple parameter settings, programs can be generated, significantly reducing the complexity of robot debugging and shortening the development process. This makes robot applications quicker and more flexible.

Dobot's collaborative robots, equipped with flexible control modes, can be operated through a variety of terminals including PCs, tablets, and teaching pendants. The use of different terminals in various scenarios enhances the efficiency of robot debugging.



## Safe Collaboration

To enhance the speed of human-machine collaboration, the industry's sole mass-produced safety skin utilizes non-contact detection to identify obstacles within a 15 cm range. This allows the robot to halt its movement before any collision, resulting in a fourfold increase in efficiency. Additionally, a new generation of independent safety controller, compliant with PLd Cat3 level, is adopted. This controller monitors real-time information such as position, speed, torque, and more for each joint. With over 20 safety features and successful tests for ISO 13849-1, ISO 10218-1, and ISO 15066, this product significantly reduces safety risks. Moreover, users can customize up to 10 sets of dual redundant safety I/O to suit their specific application scenarios.



## Fast Payback

Companies can greatly benefit from the adoption of collaborative robots, as they enable efficient labor allocation and facilitate cost reduction. These robots are incredibly convenient to implement, as they do not require any additional protective measures. Additionally, their programming process is simplified, allowing for a significant reduction in retrofitting time from months to less than a week. With a payback period of just 12 months, these robots offer a quick and effective solution for enhancing efficiency and reducing costs.

Collaborative robots offer a more cost-effective solution. By implementing incremental replacements, small and medium-sized enterprises can upgrade their automation processes without putting excessive strain on their capital investment. Moreover, unlike conventional equipment such as linear modules, collaborative robots possess the flexibility to seamlessly switch between multiple tasks. This adaptability enables them to effectively meet the evolving business needs of enterprises while maximizing equipment utilization.



## Reliable Quality

Dobot robots are synonymous with high precision and reliability, boasting an industry-leading positioning accuracy of  $\pm 0.02$  mm. Through innovative design and over 100 design verifications, Dobot guarantees enhanced productivity and superior quality when handling long and intricate tasks. As the largest collaborative robot production base in China, Dobot's reputation is unmatched. Prior to leaving the factory, each Dobot robot undergoes more than 40 rigorous tests and undergoes high-precision calibration to rectify dynamic parameter errors. This rigorous process serves as a strict assurance of their exceptional quality and excellence.

# CRA Series Collaborative Robot

Dobot has always been motivated by the pursuit of innovation and excellence. With over 1,000 global partners in the forefront of intelligent manufacturing, Dobot has successfully introduced the CRA series of collaborative robots. These robots excel in performance, safety, expansion, and flexibility, providing a superior solution for collaborative robotics. Undoubtedly, integrating these robots into your production will greatly enhance efficiency and establish a path towards intelligent manufacturing.



## Performance

Fast, accurate and stable with industry-leading motion performance

### Top-class speed

With a new all-in-one design, the joint speed has been increased to the industry's fastest one of 223°/s to fit in more application scenarios. The production beat of typical applications such as material handling can be increased by 25%, resulting in higher economic efficiency.

### Fast response

The joint servo utilizes the EtherCAT bus, offering a bandwidth at the 100M level and a joint response speed at the millisecond level. This significantly enhances the motion speed and trajectory smoothness, enabling the robot to execute a wide range of tasks with greater efficiency.

### Precise positioning

Each Dobot robot undergoes precise calibration with a laser tracker. This process ensures an absolute positioning accuracy of less than 0.4 mm, enabling the robot to handle high-precision tasks with ease. This precision brings improved consistency and quality assurance to production.

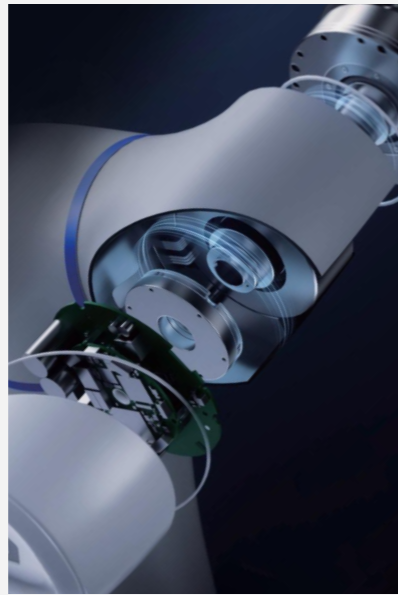

# Advanced



## Safety

Multiple safety protections to reduce production risks

### 20+ safety features

A new generation of independent safety controller, compliant with the PLd Cat3 level, has been incorporated. Equipped with over 20 safety features, this product has successfully passed safety tests including ISO 13849-1, ISO 10218-1, and ISO 15066. Following a comprehensive risk assessment, it can work in collaboration with people without the necessity for additional fencing, thereby meeting stringent safety standards.

### Electromagnetic brake

In the event of an unexpected power outage, the robot is capable of braking swiftly within 18 ms, with a drop of less than 1 mm. This feature effectively safeguards against potential damage to equipment or products.

### Custom safety strategy

Equipped with a virtual fence function and advanced non-contact safety skin, users can devise safety strategies that are more suitable for their actual production environment. This maximizes the assurance of safe production.

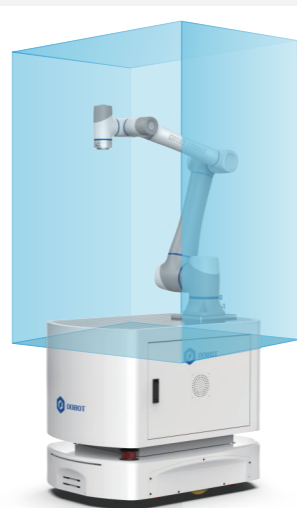

## Expansion

Abundant standard interfaces to reduce application costs

### 24 DIs and 24 DOs

The DIs and DOs of the general purpose interface have been expanded to 24, allowing for PNP and NPN switching. These interfaces can be configured into over 30 robot control and status feedback functions, catering to a wide range of equipment connections. This enhances convenience and flexibility in industrial automation, enabling seamless integration and control of equipment.

### Multiple communication protocols

The robot comes with a range of communication methods, such as Modbus TCP/RTU, EtherNet/IP, and PROFINET®, allowing for seamless connection to popular PLCs and HMIs. This enables a more efficient and convenient integration and configuration of equipment.

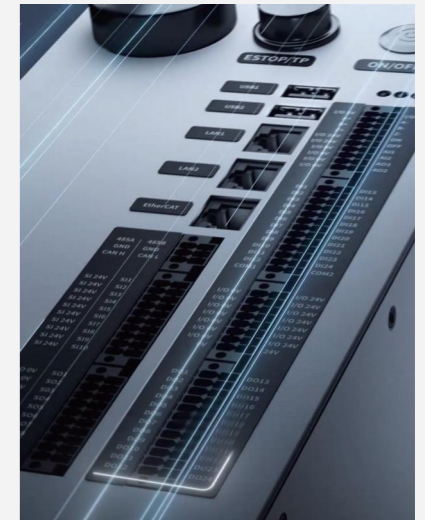

## Flexibility

Flexible operation for ease of use

### Multi-terminal operation

Dobot provides a variety of operation modes, including computer, tablet, and teaching pendant. It supports seamless switching between wired and wireless connections, providing added convenience for diverse usage scenarios.

### Intelligent interactive panel

Users can effortlessly carry out various tasks, including enabling, dragging for teaching purposes, and controlling the gripper, through the intelligent interactive panel. By offering more adaptable and user-friendly operation modes, the application and debugging processes of the robot are significantly enhanced, resulting in improved efficiency.

### Compact control cabinet

The control cabinet has been reduced in size by 20%, providing equipment manufacturers and composite robot applications with a more compact solution. Additionally, there is an option to include IP54 protection, which enhances its suitability for challenging industrial environments that involve oil and dust.



# CRAS Series

Safety is crucial in human-machine collaboration. The best solution is a safety mechanism that maintains efficiency while prioritizing safety. Dobot SafeSkin, the industry's only mass-produced safety skin, stands out by enabling non-contact monitoring and collision avoidance. This innovative technology allows collaborative robots to operate at an impressive speed of 1 m/s, four times faster than the international standard. Unlike traditional methods that require robots to slow down to avoid collisions, Dobot SafeSkin enhances efficiency and safety simultaneously. The CRAS series, built upon the efficient, flexible, and user-friendly CRA series and enhanced with Dobot SafeSkin, enables you to accomplish human-machine collaborative production with increased efficiency and safety.



## All-round protection

The SafeSkin is a wrap-around installation with comprehensive protection and excellent body perception, which is not affected by factors such as cloth and plastic gloves.

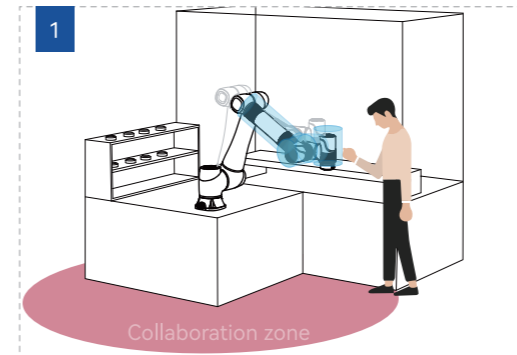
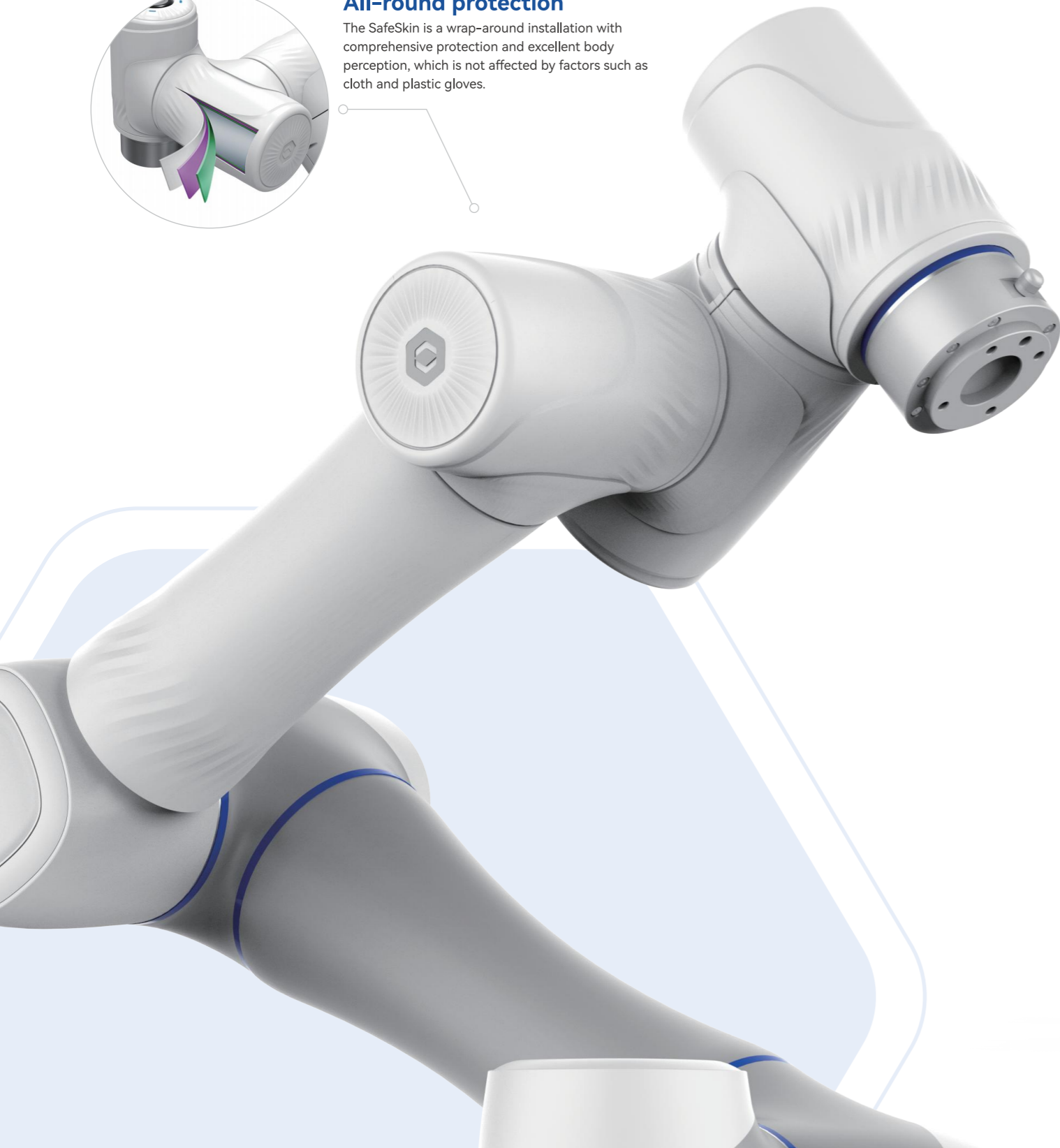

SafeSkin technology allows CRAS series robots to monitor human-machine collision risks in real-time. When the operator enters the collaboration zone, the robot can increase the maximum speed of collaboration up to 1 m/s\*, four times faster than traditional collision detection methods, while maintaining safety.

\*The data is based on the test results obtained by Dobot Laboratory under controlled conditions. As an example, CR10AS can effectively reduce the risk of robot collision at a speed of 1 m/s\*. A comprehensive safety risk assessment is required for actual applications.

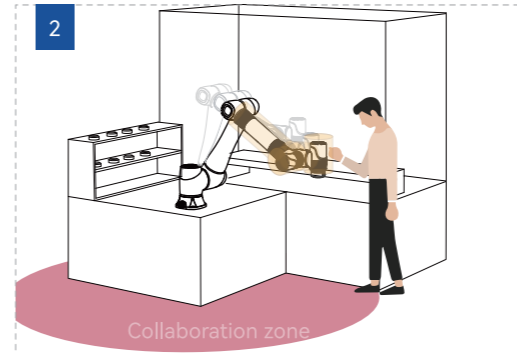

When an obstacle is detected by the SafeSkin, the CRAS collaborative robot is capable of activating its safety mechanism in just 0.01 seconds. Consequently, it promptly halts its operation within 0.1 seconds, effectively preventing collisions or minimizing the impact to enhance safety protection.



## 15cm Omnidirectional Pre-collision Perception

The SafeSkin employs a non-contact monitoring system that enables the robot to detect obstacles within a 15 cm range in real-time. This system forms a 360° anti-collision barrier, providing the robot with additional braking distance and ensuring its safe operation.

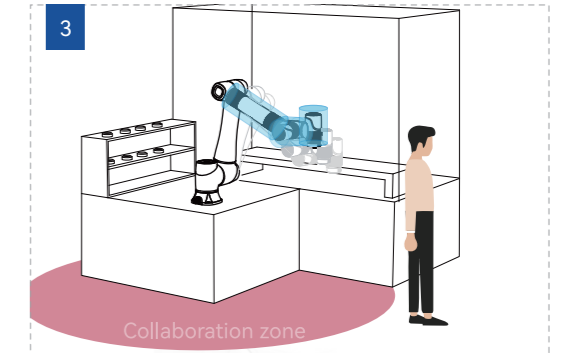

SafeSkin system detects when collision risk is eliminated, allowing seamless resumption of production program without manual intervention, enhancing human-robot collaboration efficiency.

\*The safety recovery mode can be customized.

## Safety Mechanism Comparison

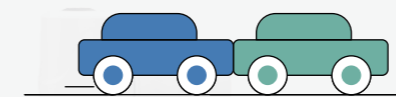

### Collision Detection

Brake after detecting a collision



### Safety and efficiency cannot be achieved simultaneously

To ensure the collision force meets safety requirements, the operation speed has to be reduced



### Pre-collision Perception

Real-time perception of collision risk



### Safety and efficiency can be achieved simultaneously

Stop before the collision so as to improve the operation speed

# DobotStudio Pro



## Ecosystem Plugins

Dobot provides a broad array of ecosystem plugins that are compatible with various types of grippers, force sensors, and 2D/3D vision accessories. Users can utilize the existing APIs to expedite the development of applications.

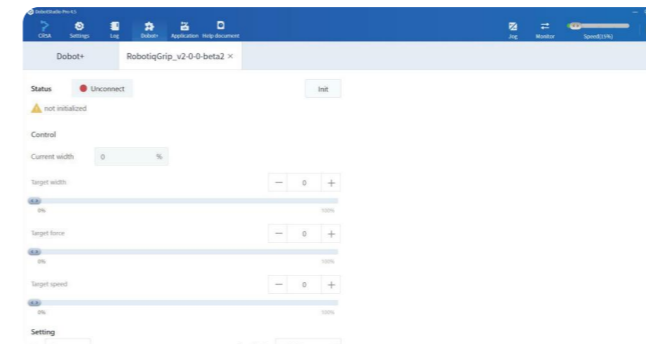

## Process Package Support

Various application process packages like welding, palletizing, and CNC are offered. Programs can be customized by tweaking parameters to improve robot application efficiency. Moreover, specialized process packages can be tailored to suit specific application needs.

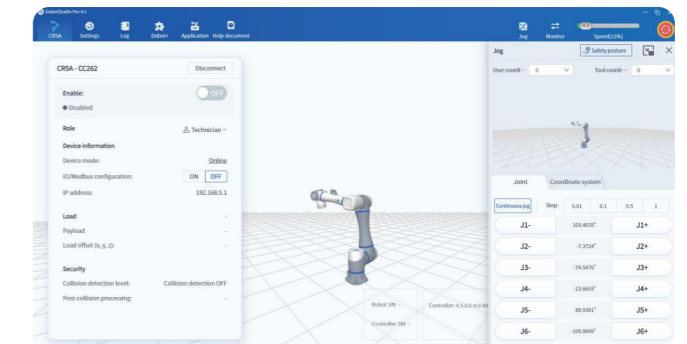

## Powerful Log Function

You can access the robot log to review past statuses, operation records, and details of parameter modifications whenever needed. This allows you to swiftly identify issues and minimize any potential downtime.

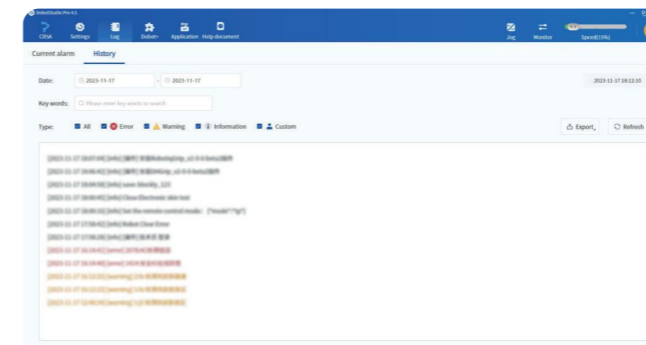

## Virtual Controller

Offline programming enables program operation, debugging, and verification to be conducted without the need for robot connection, thereby expediting project implementation.

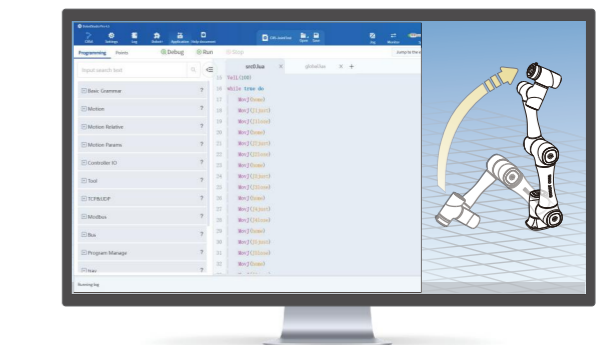

# Teaching Device (Optional)

Dobot collaborative robot teaching device has a lightweight design that integrates aesthetics and ergonomics for a comfortable grip. The interactive design is excellent, balancing safety and flexibility. It improves robot debugging efficiency and provides a great user experience.

## Blockly Programming

The blocks are easy to read and intuitive, allowing users to program robots by combining and splicing them. This balances flexibility and ease of use.

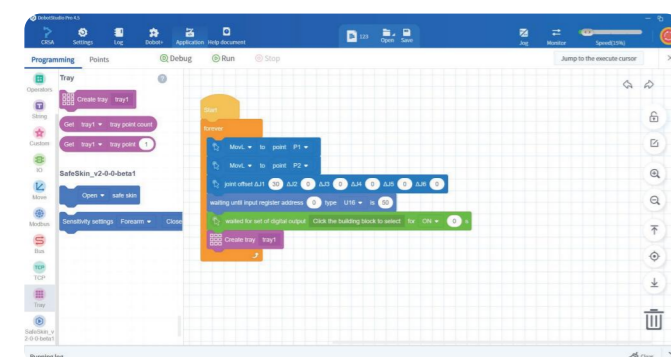

## Script Programming

Using flexible LUA script programming, experienced developers can create complex programs efficiently and handle advanced applications with ease.

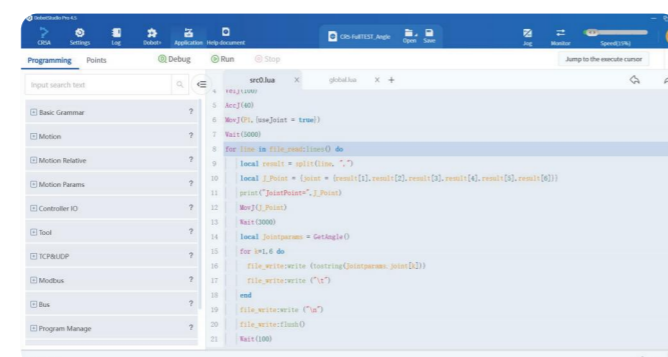

- **12 Physical Jog Buttons**  
Efficiently enhance the teaching efficiency by effortlessly managing the debugging of intricate multi-jog applications.
- **3-Position Enabling Switch**  
The three-position enabling switch or drag button can be customized to meet specific safety standards.
- **10.1-inch Ultra-clear Capacitive Touch Screen**  
The multi-touch experience is enhanced with a high resolution of 1920x1280.
- **ISO Certification**  
Certified by ISO10218-12011 and ISO13849-12015.

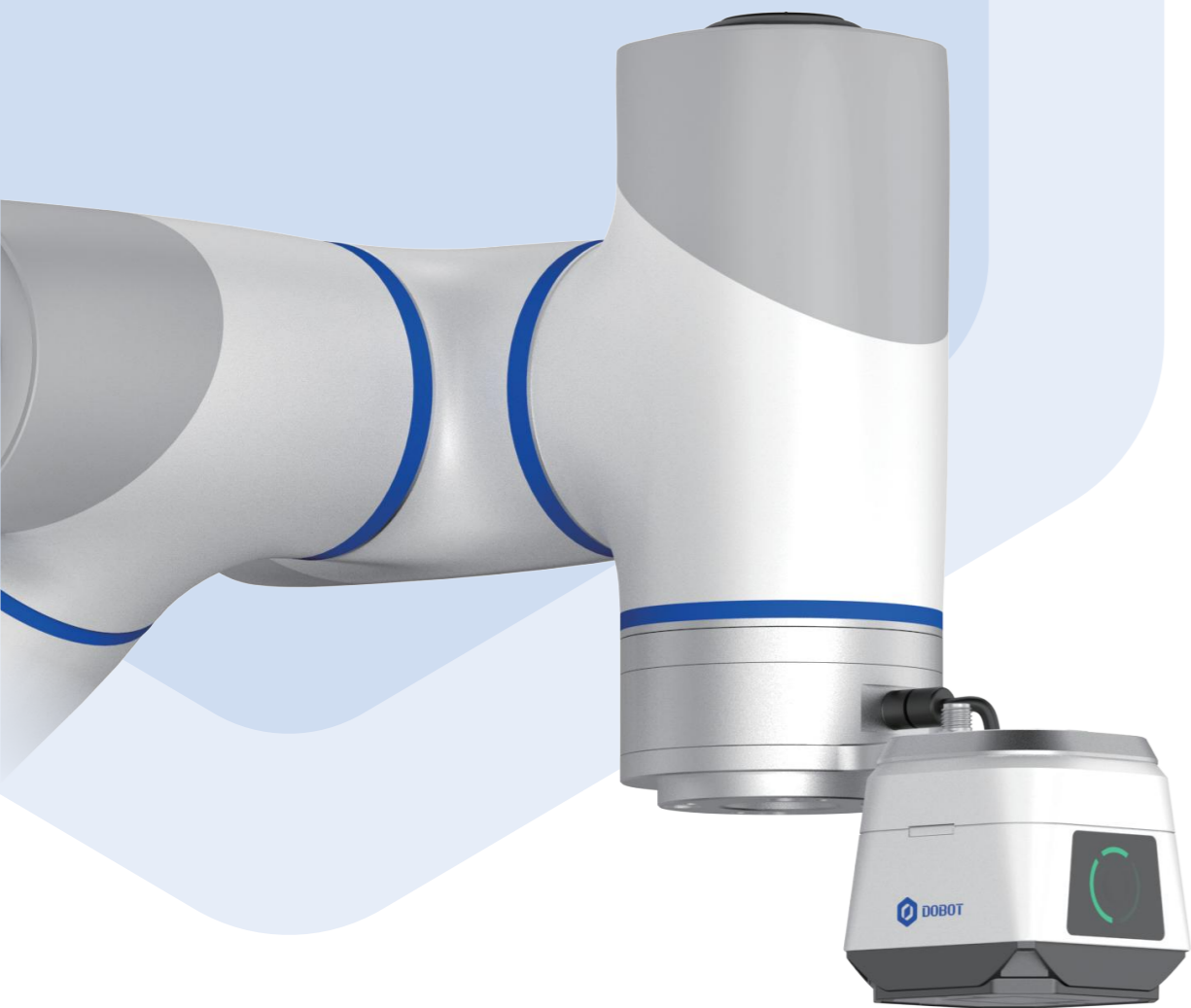

## VX500 Smart Camera

The robot's pick-and-place applications become more precise with the plug-and-play 2.5D vision technology.

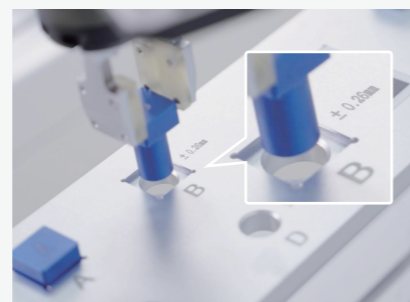
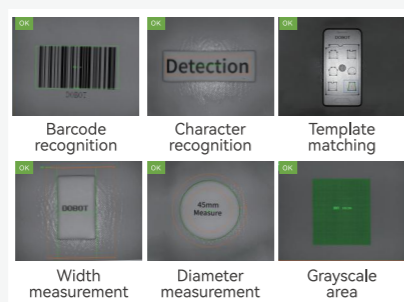
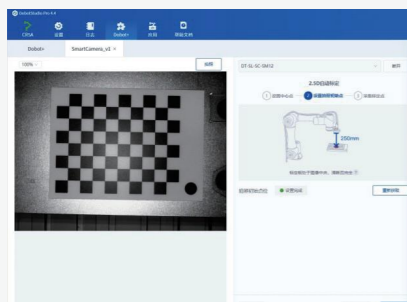

### Deeply Integrated with CRA Plug and Play

The VX500 smart camera integrates the camera, lens, light source, and vision controller. The software is built into DobotStudio Pro, with one-click automatic calibration. The vision plugin can be directly called through Blockly programming, enabling CRA series vision applications in just 30 minutes.

### Versatility Easily Achieve 'Hand-eye Coordination'

Visual positioning, presence detection, feature counting, barcode recognition, OCR character recognition, and size measurement are supported., making it easy to build various vision solutions.

### High-precision 2.5D Vision Simplify Mobile Grasping

The self-developed 2.5D algorithm can accurately identify scene height and tilt changes, and achieve a spatial compensation accuracy of  $\pm 0.26$  mm, easily solving the problem of mobile grasping positioning. It is widely used in scenarios such as composite robot's mobile handling and loading and unloading.



## Open DOBOT Ecosystem

The DOBOT Ecosystem embraces the principles of openness, compatibility, and user-friendliness, working closely with ecosystem partners to develop a range of complementary components. The CRA series offers an RS485 interface at both the end-effector and the control cabinet, facilitating the integration of ecosystem accessories like grippers, 2D/3D cameras, and force sensors through a plug-and-play approach. Moreover, the provision of standard SDKs and extensive DEMO case source code enhances the efficiency of secondary development, catering to a wide range of application requirements.



# Palletizing Solution

- The new generation CR10A\20A collaborative robot enhances palletizing speed to 8-13 items per minute, surpassing industry standards. With a maximum payload of 20 kg and a maximum palletizing height of 2100 mm, it effortlessly caters to the requirements of various sectors including food, beverage, and pharmaceutical industries.
- With the self-developed palletizing process package, users can swiftly configure palletizing patterns without the need for programming. This enables the initiation of palletizing applications in as little as 30 minutes.
- DOBOT offers integrators the opportunity to develop customized palletizing solutions with the help of its palletizing method and script support.

- The system allows for flexible configuration to pick up either one or two boxes simultaneously, resulting in a significant enhancement in palletizing efficiency. The maximum speed of palletizing can reach up to 13 boxes per minute.
 

\*Note: The data is based on the test results from Dobot Laboratory under controlled experimental conditions. The results in actual application scenarios may vary slightly.
- The flexibility of the palletizing configuration allows for customization of the order in which boxes are placed, transition points, and approach direction. This enhances the compactness and stability of the box palletizing process.
- It facilitates the task of selecting and positioning partitions while palletizing.
- The visualization of the configuration process allows for the display of parameters in a 3D format, enabling real-time switching and ultimately enhancing the interactive experience.

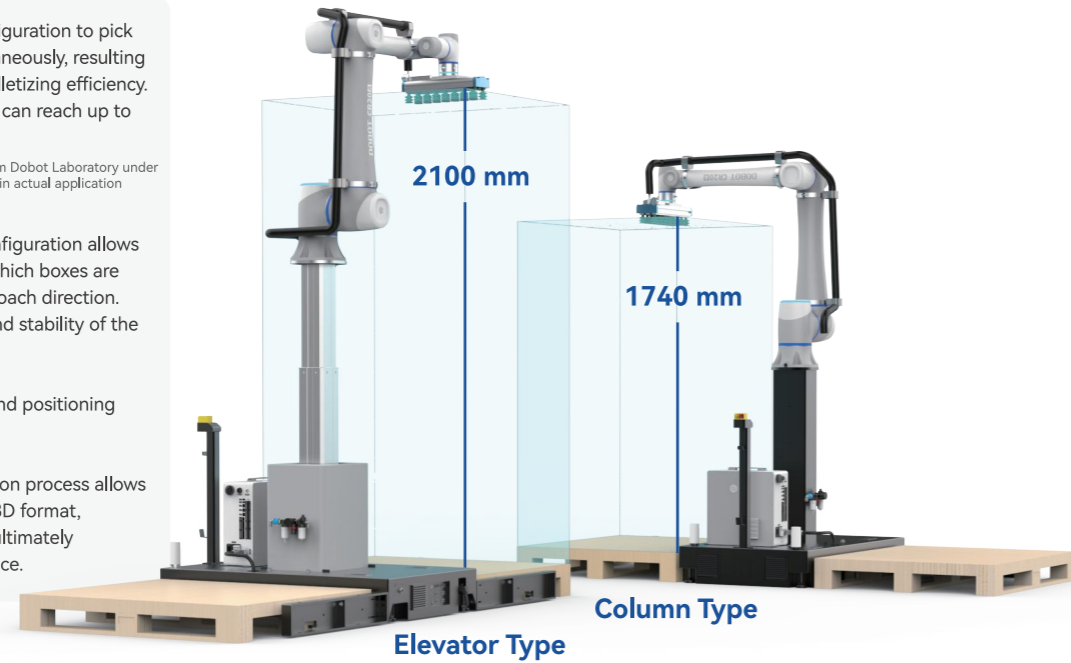

## No Programming Required Complete configuration in 30 minutes, 5 steps to start palletizing application

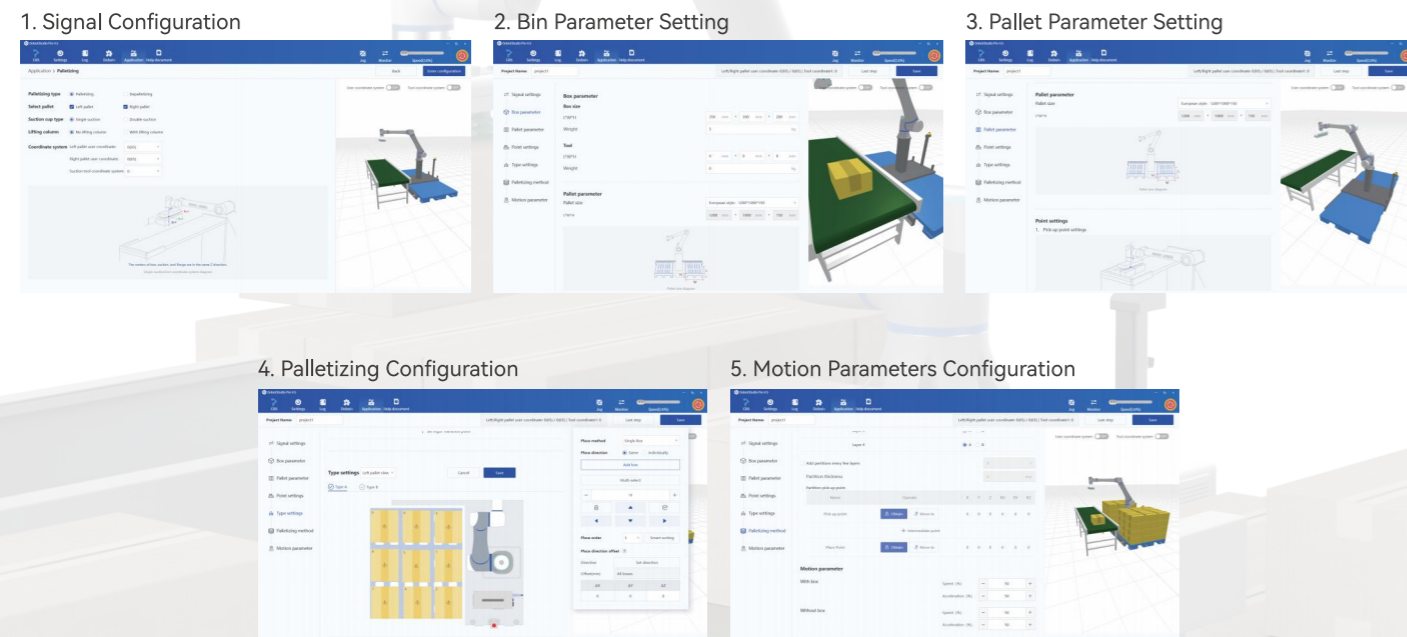

# Welding Solution

- All collaborative robots in the CRA series have undergone precise dynamic parameter calibration, guaranteeing welding trajectory accuracy of less than 0.4 mm. This calibration ensures high consistency in weld seam and stable welding quality.
- The CRA series collaborative robots are compact, sleek, and agile. They are small, lightweight, and can perform various tasks effortlessly. They excel in flexible operations across multiple workstations.
- CRA robots have a user-friendly programming interface, making them easy to program. They also offer a convenient and efficient debugging process, eliminating the need for skilled robot engineers for welding application programming. These robots effectively meet the demands of small batch and multi-variety welding production in enterprises.
- The welding process package is compatible with over 10 welding machine brands and supports advanced features like laser positioning, laser tracking, multi-layer multi-pass welding, arc starting retry, mid-way arc breaking, re-ignition, and wire sticking removal.

\*Note: Functions are continuously being developed and iterated.

## Four Simple Steps to Set Up

With the welding process package, starting the welding application is easy with just four steps: machine matching, parameter configuration, drag and drop teaching, and graphical programming for welding stimulation.

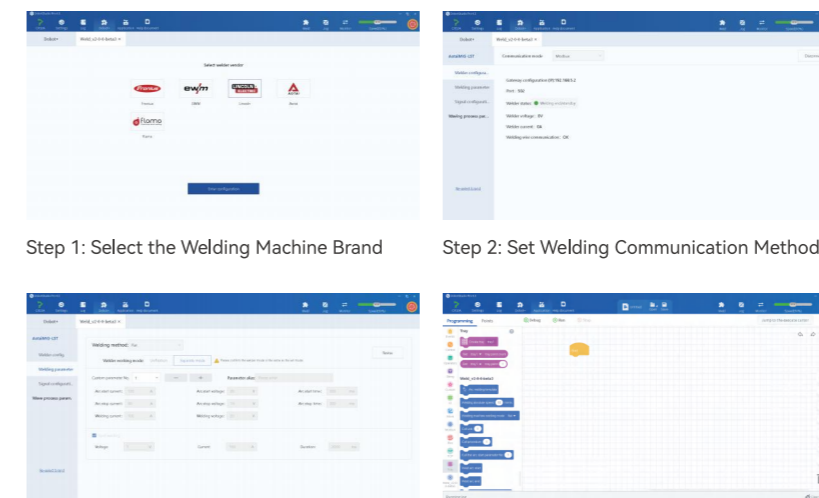

Step 1: Select the Welding Machine Brand

Step 2: Set Welding Communication Method

Step 3: Set Welding Parameters

Step 4: Graphical Programming, Start Welding

## Supports Multiple Arc Weave Modes

The welding system supports for four distinct arc weave modes, specifically triangle, spiral, trapezoid, and sine, catering to the diverse requirements of various welding situations.

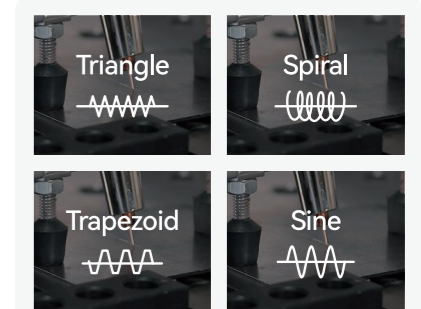

Compatible with over 10 different welding machine brands  
Provides multiple communication methods such as DeviceNet, Modbus, and analog signals





# Diverse Application Scenarios

DOBOT has been instrumental in assisting numerous Fortune 500 companies across various sectors in achieving remarkable levels of automation. The recently introduced DOBOT CRA series presents a diverse range of load capacities, ranging from 3-20 kg, and an extensive array of arm lengths. This comprehensive offering caters to over 15 industry application scenarios, encompassing 3C, automotive, semiconductor, metal processing, food, chemical, medical, and new retail. Choosing the DOBOT CRA series will undoubtedly position you as a frontrunner in the realm of intelligent manufacturing.



## 3C Industry



Home Appliance Motherboard Burning and Handling

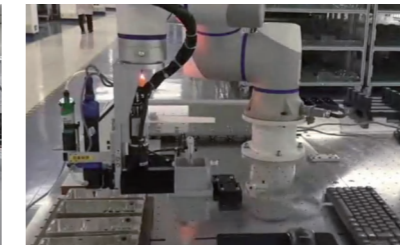

Mobile Phone Gluing

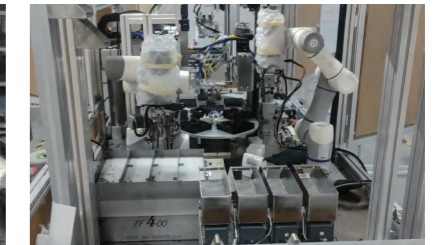

Electronic Component Sorting

## Lithium Battery Industry

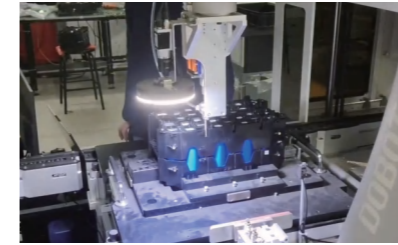

Energy Storage Battery Screw Locking



Battery Testing Loading and Unloading

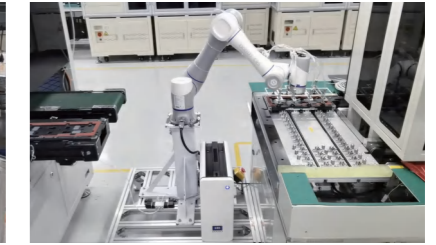

Battery Core Welding Loading and Unloading

## Semiconductor



Die Bonder Loading/Unloading



Semiconductor Plastic Encapsulation Loading/Unloading

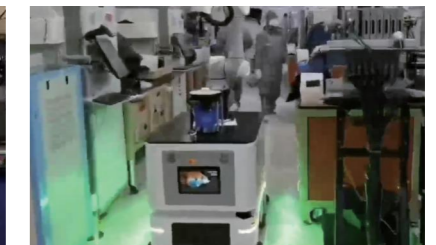

Wafer Loading/Unloading

## Plastic Chemical



Injection Molding Machine Assistance



Glue Spraying Machine Loading/Unloading



Plastic Lid Loading/Unloading

## Commercial Retail



Robot Noodle Restaurant



Latte Art Coffee Shop



Advertisement Shooting

## Automobile

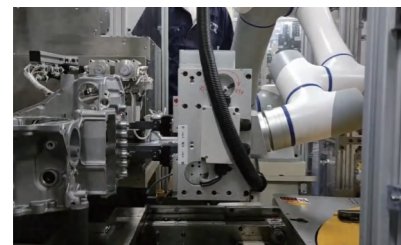

Gearbox Screw Locking



Car Door and Body Part Assembly



Automobile Glass Gluing

## Metal Processing



CNC Machine Loading/Unloading



CNC Machine Loading/Unloading (SafeSkin)



Carbon Steel Frame Welding

# Parameters

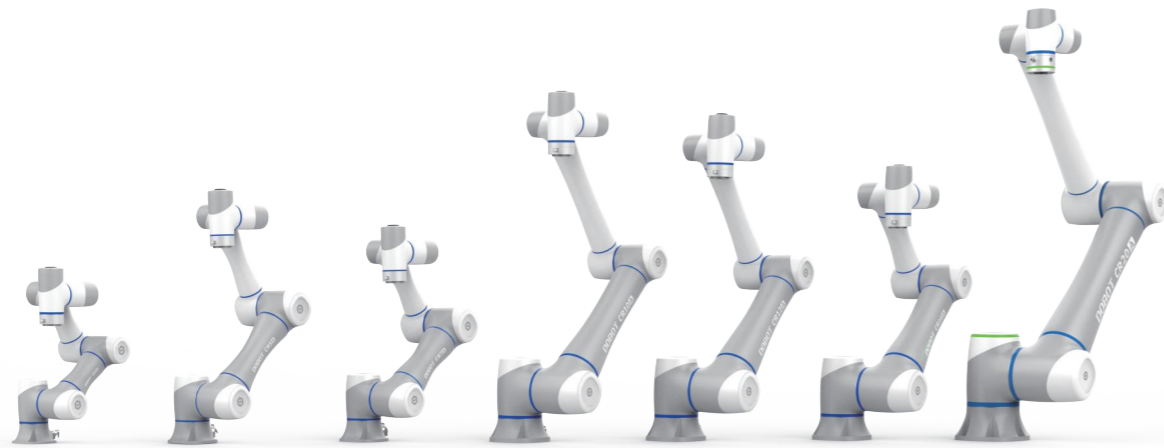

Product Name	CR3A	CR5A	CR7A	CR10A	CR12A	CR16A	CR20A
Weight	16.5 kg	25 kg	24.5 kg	40 kg	39.5 kg	40 kg	73 kg
Maximum Payload	3 kg	5 kg	7 kg	10 kg	12 kg	16 kg	20 kg
Working Radius	620 mm	900 mm	800 mm	1300 mm	1200 mm	1000 mm	1700 mm
Maximum Linear Speed	2 m/s	2 m/s	2 m/s	2 m/s	2 m/s	2 m/s	2 m/s
Joint Ranges	J3: ±155° other joints: ±360°	J3: ±160° other joints: ±360°	J3: ±160° other joints: ±360°	J3: ±160° other joints: ±360°	J3: ±160° other joints: ±360°	J3: ±160° other joints: ±360°	J3: ±165° other joints: ±360°
Maximum Joint Speed	J1/J2	180°/s	180°/s	180°/s	150°/s	150°/s	150°/s
	J3	223°/s	180°/s	180°/s	180°/s	180°/s	150°/s
	J4/J5/J6	223°/s	223°/s	223°/s	223°/s	223°/s	223°/s
End-Effector I/O Interface	DI	2	2	2	2	2	4
	DO	2	2	2	2	2	4
	AI	2 <small>(Multiplexed with RS485)</small>	2 <small>(Multiplexed with RS485)</small>	2 <small>(Multiplexed with RS485)</small>	2 <small>(Multiplexed with RS485)</small>	2 <small>(Multiplexed with RS485)</small>	2 <small>(Multiplexed with RS485)</small>
Repeatability	±0.02 mm	±0.02 mm	±0.02 mm	±0.03 mm	±0.03 mm	±0.03 mm	±0.05 mm
IP Rating	IP54	IP54	IP54	IP54	IP54	IP54	IP54
Temperature Range	0~50°C	0~50°C	0~50°C	0~50°C	0~50°C	0~50°C	0~50°C
Typical Power Consumption	120W	150W	150W	350W	350W	350W	500W
Installation	Any Angle						
Length of Cable from Body to Electric Cabinet	5 m	5 m	5 m	5 m	5 m	5 m	6 m
Material	Aluminum Alloy, ABS Plastic						



## Robot Control Cabinet

	CC262	CC263
Dimensions	345 mm*345 mm*145 mm	400 mm*400 mm*175 mm
Weight	9.5 kg (AC input), 8.5 kg (DC input)	15 kg (AC input)
Input Power	AC Input: 100~240V, 47~63Hz DC Input: 30~60V	AC Input: 100~240V, 47~63Hz
IO Power	24V, Max 3A, 0.5A max. per channel	
IO Interface	DI DO AI AO	24 Channels (NPN or PNP) 24 Channels (NPN or PNP) 2 Channels, Voltage/Current Mode, 0~10V, 4~20mA 2 Channels, Voltage/Current Mode, 0~10V, 4~20mA
Communication Interface	Network interface USB 485 Interface Encoder	2, used for TCP/IP, Modbus TCP, EtherNet/IP, PROFINET communication 2, used for file import and export 1, used for RS485, Modbus RTU communication 1, ABZ incremental encoder interface
Working Environment	Temperature	0~50°C, humidity ≤95%, non-condensing
IP Rating	IP20 (optional IP54)	
Teaching Method	PC, APP (Android), Teaching Device	
Adaptable Models	CR3A~CR16A	CR20A

## DOBOT Collaborative Robot Teaching Device

Product Model	DT-TP10-3PE-N
Dimensions (Length*Width*Height)	290*180*41 (mm)
Resolution	1920*1200@60Hz
Screen Size	10.1 Inches
IP Rating	IP54
Weight	1.02 kg
Standard Cable Length	5 m
Material	PC + ABS

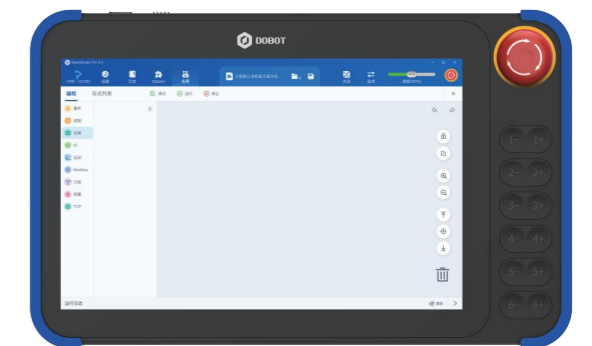



 Dobot Europe GmbH  
Werner-Heisenberg-Straße 2, 63263 Neu-Isenburg, Germany

 [www.dobot-robots.com](http://www.dobot-robots.com)

 [sales@dobot-robots.com](mailto:sales@dobot-robots.com)

 [linkedin.com/company/dobot-industry](https://www.linkedin.com/company/dobot-industry)

 [youtube.com/@dobotarm](https://www.youtube.com/@dobotarm)



D20240109